



Product Summary

V _{(BR)DSS}	R _{DS(on)TYP}	I _D
-40V	95mΩ@-10V	-2.6A
	120mΩ@-4.5V	

Feature

- Trench Technology Power MOSFET
- Low R_{DS(ON)}
- Low Gate Charge

Application

- DC/DC Converter
- Load Switch for Portable Devices
- Battery Switch

MARKING:

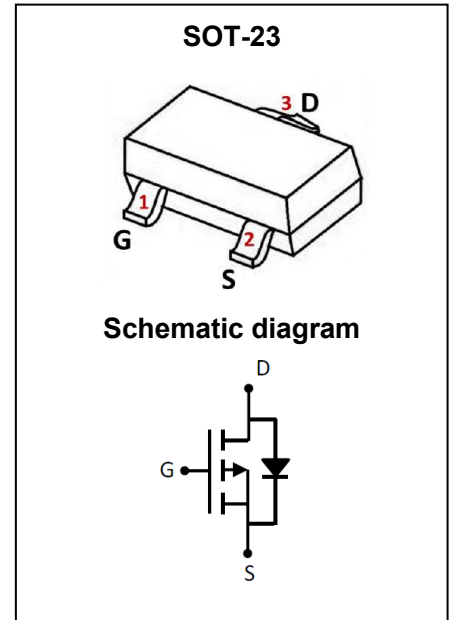
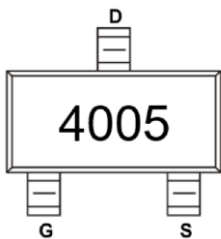

ABSOLUTE MAXIMUM RATINGS (T_A = 25°C unless otherwise noted)

Parameter	Symbol	Value	Unit	
Drain-Source Voltage	V _{DS}	-40	V	
Gate-Source Voltage	V _{GS}	±20	V	
Continuous Drain Current ^{1,5}	I _D	T _A = 25°C	-2.6	A
		T _A = 100°C	-2.2	
Pulsed Drain Current ²	I _{DM}	-13	A	
Power Dissipation ^{4,5}	P _D	1.4	W	
Thermal Resistance from Junction to Ambient ⁵	R _{θJA}	90	°C/W	
Junction Temperature	T _J	150	°C	
Storage Temperature	T _{STG}	-55~ +150	°C	

MOSFET ELECTRICAL CHARACTERISTICS ($T_A = 25^\circ\text{C}$ unless otherwise noted)

Parameter	Symbol	Test Condition	Min	Type	Max	Unit
Off Characteristics						
Drain-Source Breakdown Voltage	$V_{(BR)DSS}$	$V_{GS} = 0V, I_D = -250\mu A$	-40			V
Zero Gate Voltage Drain Current	I_{DSS}	$V_{DS} = -40V, V_{GS} = 0V$			-1	μA
Gate-Body Leakage Current	I_{GSS}	$V_{GS} = \pm 20V, V_{DS} = 0V$			± 100	nA
On Characteristics³						
Gate Threshold Voltage	$V_{GS(th)}$	$V_{DS} = V_{GS}, I_D = -250\mu A$	-1	-1.6	-3	V
Drain-Source On-Resistance	$R_{DS(on)}$	$V_{GS} = -10V, I_D = -3A$		95	130	m Ω
		$V_{GS} = -4.5V, I_D = -3A$		120	150	
Dynamic Characteristics⁴						
Input Capacitance	C_{iss}	$V_{DS} = -20V, V_{GS} = 0V, f = 1MHz$		272		pF
Output Capacitance	C_{oss}			24		
Reverse Transfer Capacitance	C_{rss}			20		
Gate Resistance	R_g	$V_{DS} = 0V, V_{GS} = 0V, f = 1MHz$		26		Ω
Switching Characteristics⁴						
Total Gate Charge	Q_g	$V_{DS} = -20V, V_{GS} = -10V, I_D = -3A$		6		nC
Gate-Source Charge	Q_{gs}			0.95		
Gate-Drain Charge	Q_{gd}			1.0		
Turn-On Delay Time	$t_{d(on)}$	$V_{DD} = -15V, V_{GS} = -10V,$ $R_L = 5.76\Omega, R_G = 3\Omega$		6		ns
Turn-On Rise Time	t_r			3.5		
Turn-Off Delay Time	$t_{d(off)}$			20		
Turn-Off Fall Time	t_f			5		
Source-Drain Diode Characteristics						
Diode Forward Voltage ³	V_{SD}	$V_{GS} = 0V, I_S = -4A$			-1.2	V

Notes :

- 1.The maximum current rating is limited by package.
- 2.Pulse Test : Pulse Width $\leq 10\mu s$, duty cycle $\leq 1\%$.
- 3.Pulse Test : Pulse Width $\leq 300\mu s$, duty cycle $\leq 2\%$.
- 4.The power dissipation P_D is limited by $T_{J(MAX)} = 150^\circ\text{C}$.
- 5.Device mounted on $1in^2$ FR-4 board with 2oz. Copper, in a still air environment with $T_A = 25^\circ\text{C}$.

Typical Characteristics

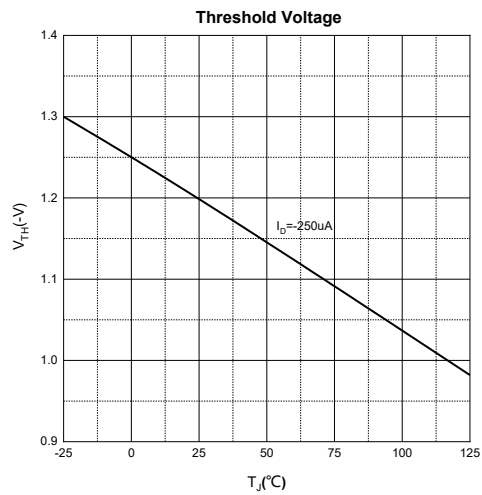
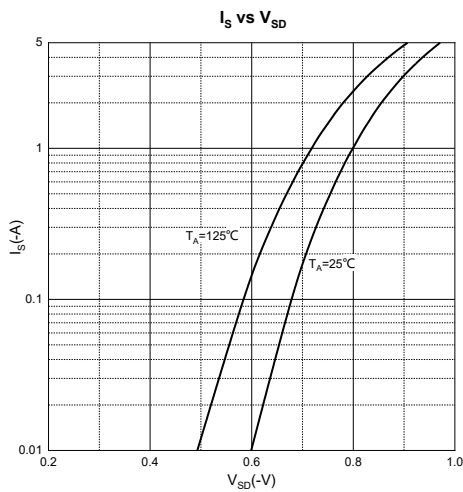
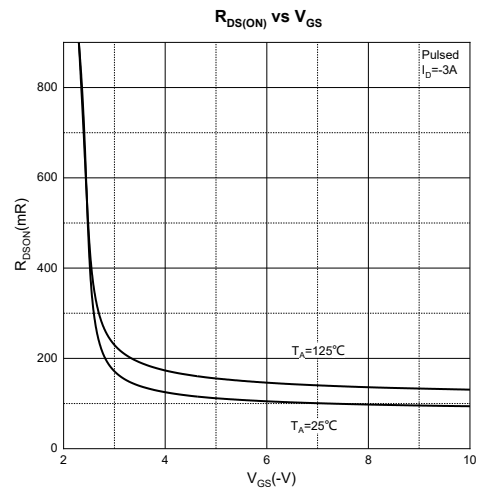
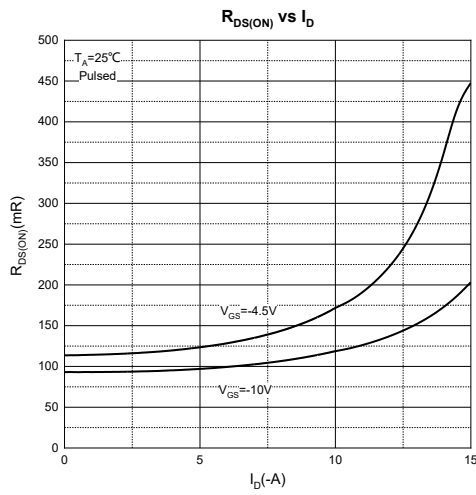
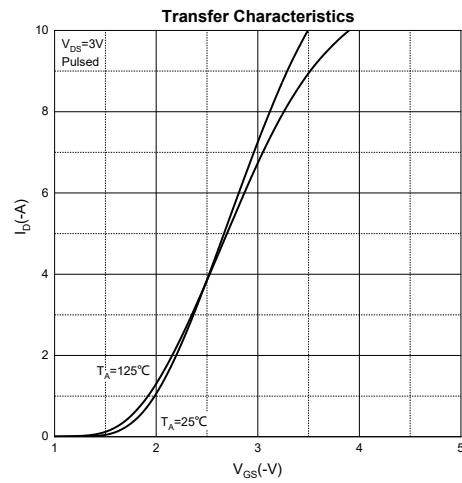
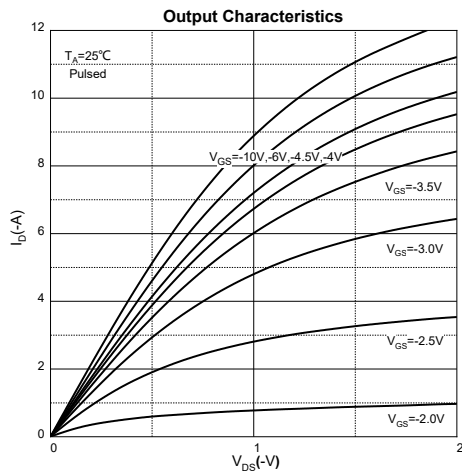

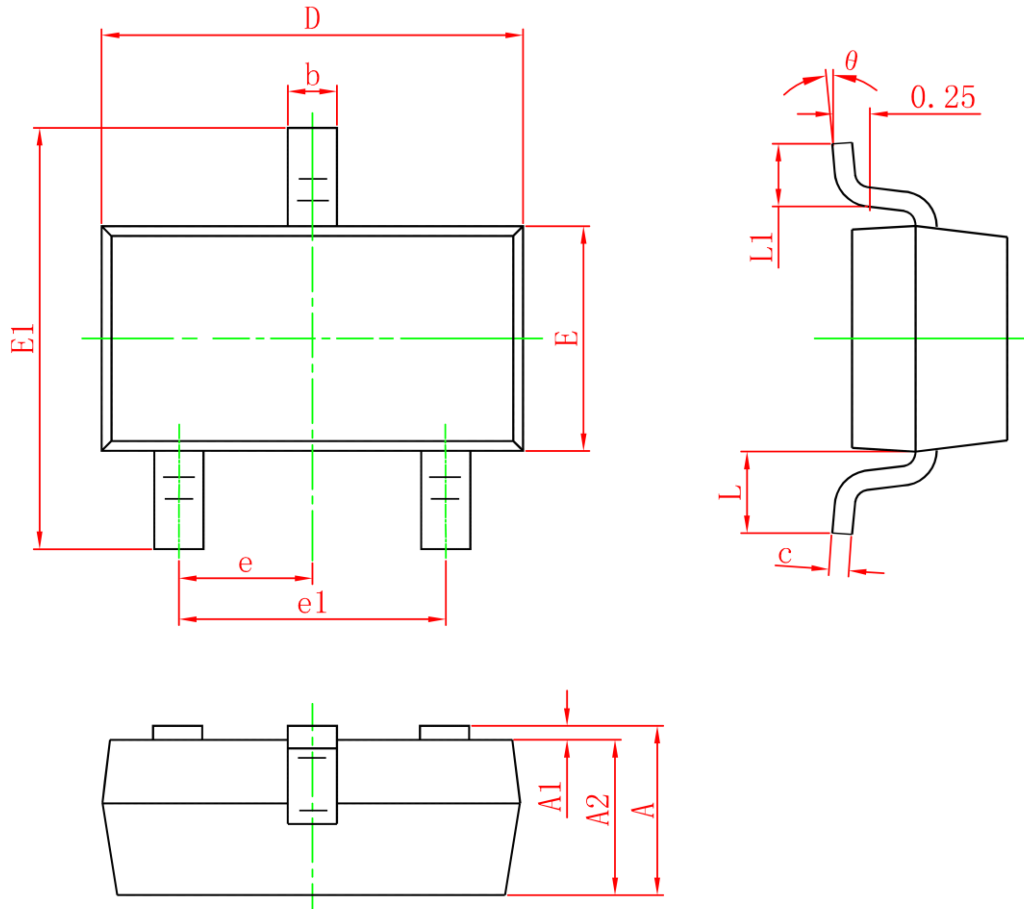
SOT-23 Package Information

Symbol	Dimensions In Millimeters		Dimensions In Inches	
	Min.	Max.	Min.	Max.
A	0.900	1.150	0.035	0.045
A1	0	0.100	0	0.004
A2	0.900	1.050	0.035	0.041
b	0.300	0.500	0.012	0.020
c	0.080	0.150	0.003	0.006
D	2.800	3.000	0.110	0.118
E	1.150	1.500	0.045	0.059
E1	2.250	2.650	0.089	0.104
e	0.950TYP		0.037TYP	
e1	1.800	2.000	0.071	0.079
L	0.550REF		0.022REF	
L1	0.300	0.500	0.012	0.020
θ	0°	8°	0°	8°

Attention:

- GreenPower Electronics reserves the right to improve product design function and reliability without notice.
- Any and all semiconductor products have certain probability to fail or malfunction, which may result in personal injury, death or property damage. Customer are solely responsible for providing adequate safe measures when design their systems.
- GreenPower Electronics products belong to consumer electronics or other civilian electronic products.